



PRODUCT CATALOGUE

OVERVIEW OF RAPID



Our company has great location about 100km away from Shanghai Port, in which just 30 minutes away from Shanghai by train and one hour by car. Workshop area covers about 30,000m², and warehouse about 10,000m².

Rapid Scaffolding takes pride in having a team of highly experienced and suitably qualified engineering and technical experts. According to different requests from our clients, we can provide a whole range of scaffolding and formwork designing. We provide one-stop service for any project. We have a highly experienced production team, which maintains top level of every stage of the production progress. Each team of workers is led by a supervisor who monitors daily works. Automated welding and robot welding systems are widely used. We develop new steel plank forming machine, which increases plank production capacity, about 1,000pcs per day. With experienced workers, advanced machines and good management, our capacity is about 25,000tons per year.

We have a complete quality control system, which guarantees the high quality of our products and assure all process is due to schedule. Rapid Scaffolding (Engineering) Co., Ltd. has obtained ISO9001 Accreditation, CE, ISO14001, OHSAS18001. All our scaffolding systems are tested to confirm to ANSIA10.8, AS/NZS1576.3. Japan standard JIS.

RAPID SCAFFOLDING(ENGINEERING)CO.,LTD.

Rapid Scaffolding (Engineering) Co., Ltd. is a leading company in scaffolding industry in China. Since its establishment in 2003, RS has grown to take on new challenges and its continued success comes from valuing its clients and employees and a commitment to service, performance and quality. We are not only the expert in designing and manufacturing all kinds of steel scaffoldings and formwork system, but also we devote to being an expert in developing aluminum scaffoldings. Our main products include Ringlock (Allround), Cup-lock, Kwikstage, Haky, Frames, Props, etc.



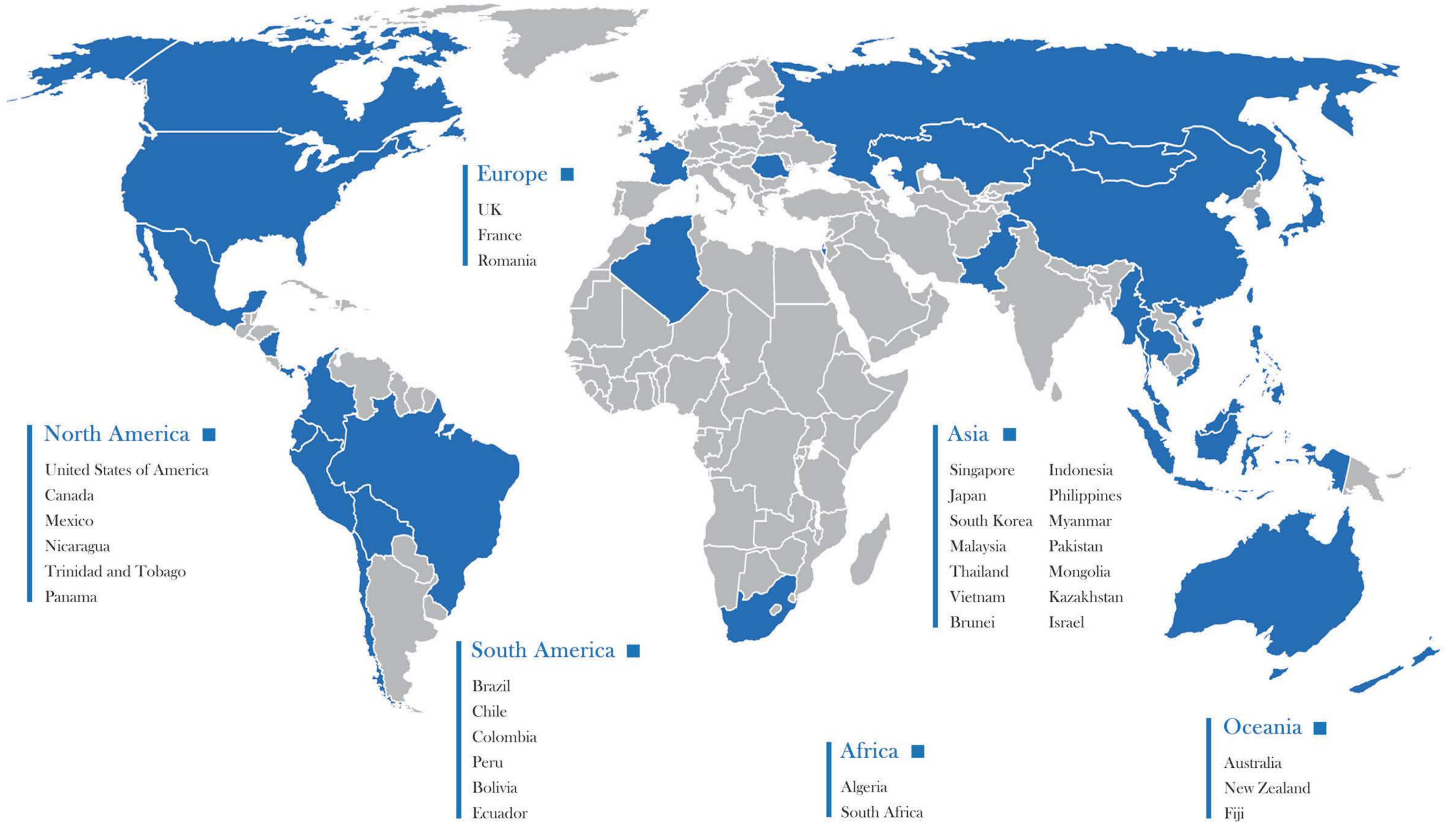

Ringlock Standard

FINISH: Hot-dip Galvanized



ITEM NO.	MATERIAL	L	WEIGHT APPROX.
RSRS 050	Q355 48.3 × 3.2mm	0.5m	3.09kg
RSRS 100	Q355 48.3 × 3.2mm	1.0m	5.52kg
RSRS 150	Q355 48.3 × 3.2mm	1.5m	7.95kg
RSRS 200	Q355 48.3 × 3.2mm	2.0m	10.38kg
RSRS 250	Q355 48.3 × 3.2mm	2.5m	12.80kg
RSRS 300	Q355 48.3 × 3.2mm	3.0m	15.23kg

Ringlock Ledger

FINISH: Hot-dip Galvanized



ITEM NO.	MATERIAL	L	WEIGHT APPROX.
RSRL 073	Q355 48.3 × 3.2mm	0.73m	3.42kg
RSRL 104	Q355 48.3 × 3.2mm	1.04m	4.61kg
RSRL 109	Q355 48.3 × 3.2mm	1.09m	4.80kg
RSRL 140	Q355 48.3 × 3.2mm	1.40m	5.98kg
RSRL 157	Q355 48.3 × 3.2mm	1.57m	6.62kg
RSRL 207	Q355 48.3 × 3.2mm	2.07m	8.53kg
RSRL 257	Q355 48.3 × 3.2mm	2.57m	10.44kg
RSRL 307	Q355 48.3 × 3.2mm	3.07m	12.34kg

Ringlock Scaffolding

Quick erection:All Ringlock scaffolds are pre-measured and just a hammer is required when erection.

Versatility: The revolutionary node point-rosette provides up to 8 connections in one plane, allowing the system scaffolding highly adaptable for straight and curved structures, such as ship yards, power generation stations, petrochemical plants.

Low maintenance: The hot dip galvanized finish will greatly extend life of the product, no paint required, no more rust or corrosion, even they can be stored externally.

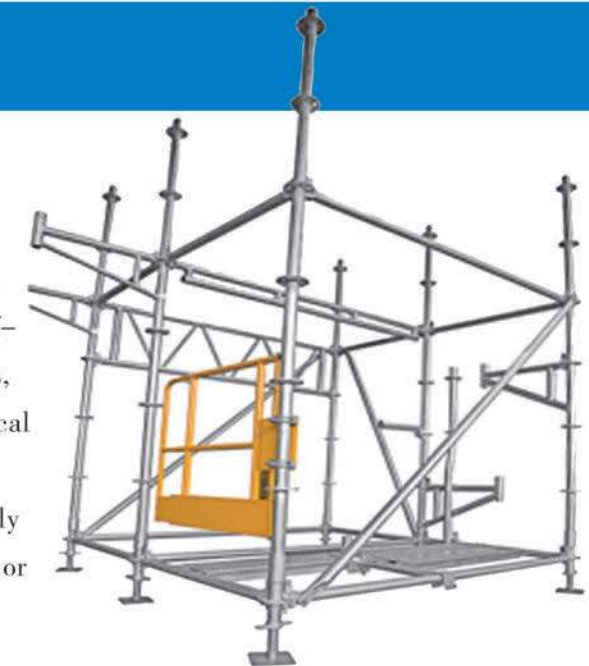

Ringlock Diagonal Brace

FINISH: Hot-dip Galvanized



ITEM NO.	MATERIAL	W × H	WEIGHT APPROX.
RSRB 2120	Q235 48.3 × 2.5mm	0.73 × 2m	8.09kg
RSRB 2230	Q235 48.3 × 2.5mm	1.04 × 2m	8.40kg
RSRB 2250	Q235 48.3 × 2.5mm	1.09 × 2m	8.47kg
RSRB 2400	Q235 48.3 × 2.5mm	1.40 × 2m	8.91kg
RSRB 2490	Q235 48.3 × 2.5mm	1.57 × 2m	9.20kg
RSRB 2810	Q235 48.3 × 2.5mm	2.07 × 2m	10.16kg
RSRB 3180	Q235 48.3 × 2.5mm	2.57 × 2m	11.28kg
RSRB 3580	Q235 48.3 × 2.5mm	3.07 × 2m	12.49kg

Bridge Ledger

FINISH: Hot-dip Galvanized



ITEM NO.	MATERIAL	L
RSBL 157	Q235	1.57m
RSBL 207	Q235	2.07m
RSBL 257	Q235	2.57m
RSBL 307	Q235	3.07m

ITEM NO.	MATERIAL	L
RSRBB 036	Q235	0.36m
RSRBB 039	Q235	0.39m
RSRBB 073	Q235	0.73m
RSRBB 109	Q235	1.09m

Ringlock Board Bracket

FINISH: Hot-dip Galvanized



Lattice Girder

FINISH: Hot-dip Galvanized

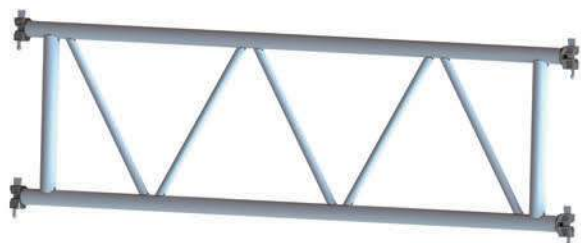

ITEM NO.	MATERIAL	L
RSLG 207	Q235	2.07m
RSLG 257	Q235	2.57m
RSLG 307	Q235	3.07m
RSLG 414	Q235	4.14m
RSLG 514	Q235	5.14m
RSLG 614	Q235	6.14m

Octagonlock Scaffolding

Octagonlock system—our patent product. It is a modular system scaffold which can provide major savings in labor costs while meet the requirement of safety, easy handling and reduction in maintenance. It is also suitable for many types of structure and project conditions. It can extend in 8 directions and is more stable. The efficiency of erecting and dismantling of Octagonlock is at least 4 times of tube & coupler, and 2 times of cuplock.

Octagonlock Standard [Light duty]

FINISH: Hot-dip Galvanized



ITEM NO.	MATERIAL	L	WEIGHT APPROX.
RSOS 050	Q355 48.3 × 3.2mm	0.5m	3.07kg
RSOS 100	Q355 48.3 × 3.2mm	1.0m	5.54kg
RSOS 150	Q355 48.3 × 3.2mm	1.5m	8.01kg
RSOS 200	Q355 48.3 × 3.2mm	2.0m	10.48kg
RSOS 250	Q355 48.3 × 3.2mm	2.5m	12.95kg
RSOS 300	Q355 48.3 × 3.2mm	3.0m	15.42kg

[Heavy duty] FINISH: Hot-dip Galvanized

ITEM NO.	MATERIAL	L	WEIGHT APPROX.
RSHS 050	Q355 60.3 × 3.2mm	0.5m	3.84kg
RSHS 100	Q355 60.3 × 3.2mm	1.0m	6.91kg
RSHS 150	Q355 60.3 × 3.2mm	1.5m	9.99kg
RSHS 200	Q355 60.3 × 3.2mm	2.0m	13.18kg
RSHS 250	Q355 60.3 × 3.2mm	2.5m	16.29kg
RSHS 300	Q355 60.3 × 3.2mm	3.0m	19.21kg

Octagonlock Ledger

FINISH: Hot-dip Galvanized



ITEM NO.	MATERIAL	L	WEIGHT APPROX.
RSOL 060	Q235 48.3 × 2.5mm	0.60m	2.31kg
RSOL 090	Q235 48.3 × 2.5mm	0.90m	3.22kg
RSOL 120	Q235 48.3 × 2.5mm	1.20m	4.12kg
RSOL 150	Q235 48.3 × 2.5mm	1.50m	5.03kg
RSOL 180	Q235 48.3 × 2.5mm	1.80m	5.94kg
RSOL 200	Q235 48.3 × 2.5mm	2.00m	6.54kg
RSOL 240	Q235 48.3 × 2.5mm	2.40m	7.75kg

Octagonlock Diagonal Brace

FINISH: Hot-dip Galvanized

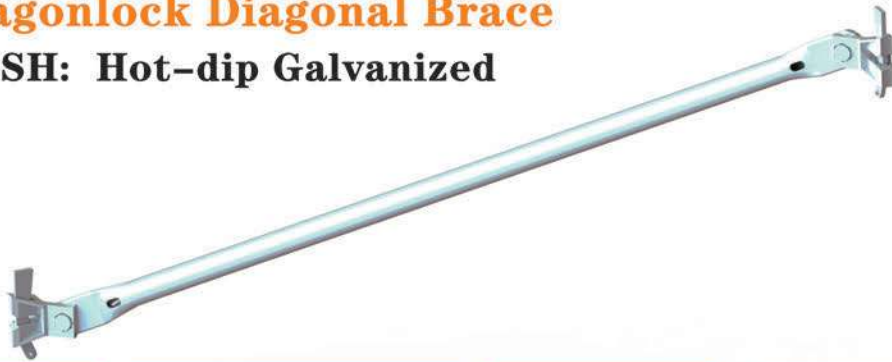

ITEM NO.	MATERIAL	W × H	WEIGHT APPROX.
RSOB 2088	Q235 33 × 2.4mm	0.60 × 2.0m	4.84kg
RSOB 2193	Q235 33 × 2.4mm	0.90 × 2.0m	5.00kg
RSOB 2332	Q235 33 × 2.4mm	1.20 × 2.0m	5.23kg
RSOB 2500	Q235 33 × 2.4mm	1.50 × 2.0m	5.52kg
RSOB 2691	Q235 33 × 2.4mm	1.80 × 2.0m	5.86kg
RSOB 2828	Q235 33 × 2.4mm	2.00 × 2.0m	6.11kg
RSOB 2828	Q235 33 × 2.4mm	2.40 × 2.0m	6.66kg

Octagonlock Board Bracket

FINISH: Hot-dip Galvanized



ITEM NO.	MATERIAL	L
RSOBB 030	Q235	0.36m
RSOBB 060	Q235	0.60m
RSOBB 090	Q235	0.90m

The material grade Q355 (GB standard) means the yield strength is ≥ 355 Mpa, the tensile strength is between 450 Mpa to 630 Mpa, which is very close to STK500 (JIS standard) or S355 (EN standard).

The material grade Q235 (GB standard) means the yield strength is ≥ 235 Mpa, the tensile strength is between 370 Mpa to 500 Mpa, which is very close to STK400 (JIS standard) or S235 (EN standard).

Accessories

Aluminum Robust Hatch-type



ITEM NO.	L	W	MATERIAL
RSRH 157	1.57m	0.61/0.62m	Aluminum & Plywood
RSRH 207	2.07m	0.61/0.62m	Aluminum & Plywood
RSRH 257	2.57m	0.61/0.62m	Aluminum & Plywood
RSRH 307	3.07m	0.61/0.62m	Aluminum & Plywood

Steel Plank FINISH: Hot-dip Galvanized

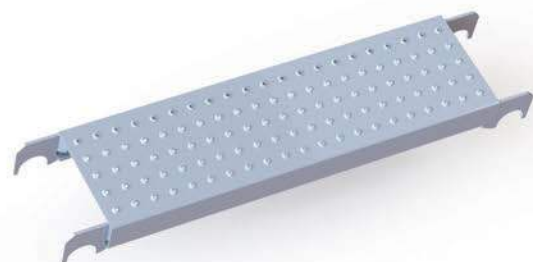

ITEM NO.	L	W	WEIGHT APPROX.
RSSSP 073	0.73m	0.2286m	5.63kg
RSSSP 104	1.04m	0.2286m	7.55kg
RSSSP 109	1.09m	0.2286m	7.86kg
RSSSP 140	1.40m	0.2286m	9.78kg
RSSSP 157	1.57m	0.2286m	10.83kg
RSSSP 207	2.07m	0.2286m	13.93kg
RSSSP 257	2.57m	0.2286m	17.03kg
RSSSP 307	3.07m	0.2286m	20.12kg

Steel Plank FINISH: Hot-dip Galvanized



ITEM NO.	L	W	WEIGHT APPROX.
RSDWP 073	0.73m	0.32m	8.37kg
RSDWP 104	1.04m	0.32m	10.62kg
RSDWP 109	1.09m	0.32m	10.98kg
RSDWP 140	1.40m	0.32m	13.23kg
RSDWP 157	1.57m	0.32m	14.46kg
RSDWP 207	2.07m	0.32m	18.09kg
RSDWP 257	2.57m	0.32m	21.71kg
RSDWP 307	3.07m	0.32m	25.33kg

Steel Plank FINISH: Hot-dip Galvanized

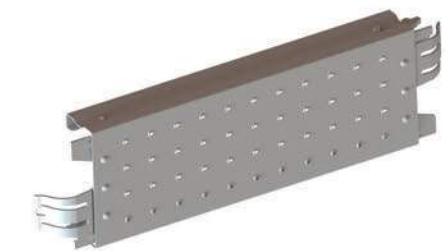

ITEM NO.	L	W	WEIGHT APPROX.
RSDEP 073	0.73m	0.241m	5.85kg
RSDEP 104	1.04m	0.241m	7.60kg
RSDEP 109	1.09m	0.241m	7.88kg
RSDEP 140	1.40m	0.241m	9.62kg
RSDEP 157	1.57m	0.241m	10.58kg
RSDEP 207	2.07m	0.241m	13.39kg
RSDEP 257	2.57m	0.241m	16.20kg
RSDEP 307	3.07m	0.241m	19.01kg

Other Accessories

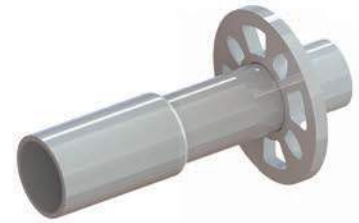

Ringlock Base Collar



End and Coupler



Double Ends



Head Screw Jack



U-head Screw Jack



Base Jack



Swivel Base Jack



Caster



Ladder



Ladder Bracket

Other Accessories

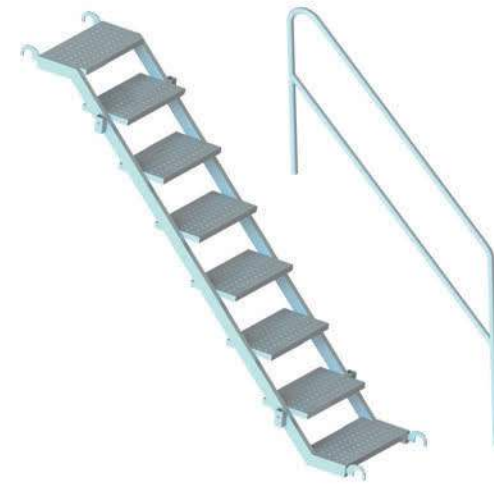

Steel Stair



Oblique Ladder



Mountable Ladder

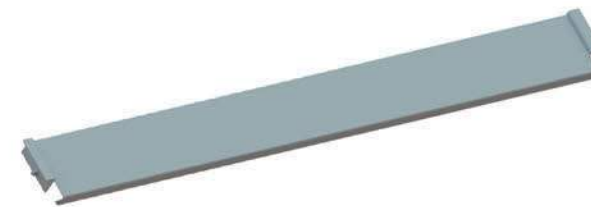

Toeboard

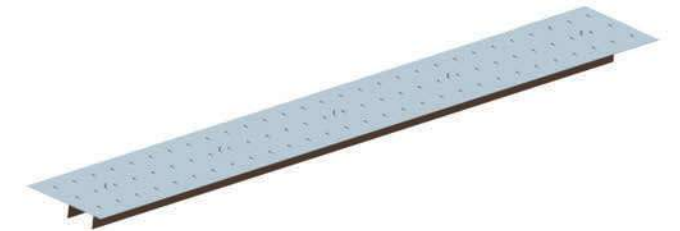

Gap cover



Wall Tie



Safety Gate

Frame Scaffolding

Japanese Frame Scaffolding FINISH: Hot-dip Galvanized

ITEM NO.	W	H
RSJF 01	0.41m	1.7m
RSJF 02	0.61m	1.7m

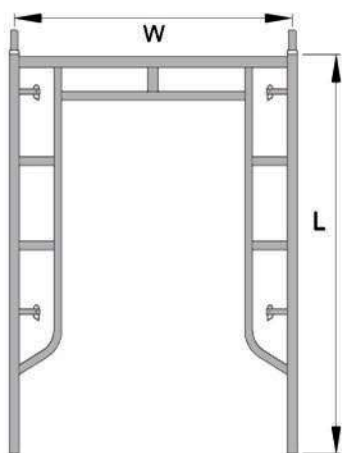
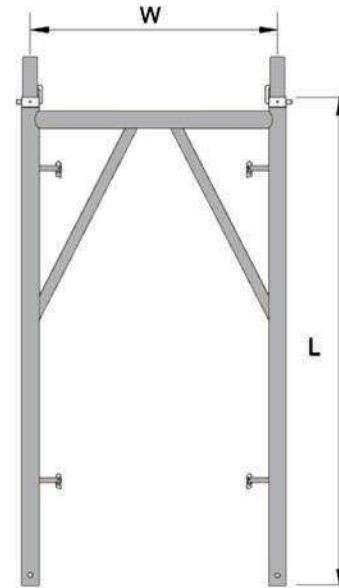

Japanese Frame Scaffolding FINISH: Hot-dip Galvanized

ITEM NO.	W	H
RSJF 03	1.219m	1.524m
RSJF 04	1.219m	1.700m
RSJF 05	1.219m	1.930m

Japanese Frame Scaffolding FINISH: Hot-dip Galvanized

ITEM NO.	W	H
RSJF 06	1.219m	0.914m
RSJF 07	1.219m	1.219m

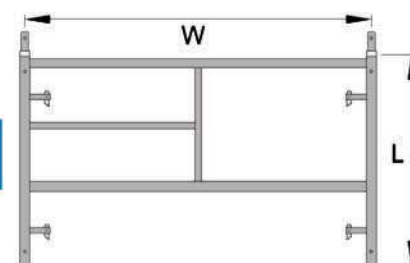

American Mason Frame/Step Frame FINISH: Powder Coated

ITEM NO.	W	H
RSF 01	4'(1.219m)	5'(1.524m)
RSF 02	5'(1.524m)	3'(0.914m)
RSF 03	5'(1.524m)	4'(1.219m)
RSF 04	5'(1.524m)	5'(1.524m)
RSF 05	5'(1.524m)	6'4"(1.930m)

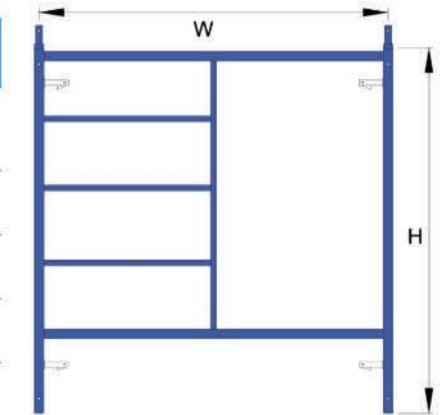

American Walk Through Frame FINISH: Powder Coated

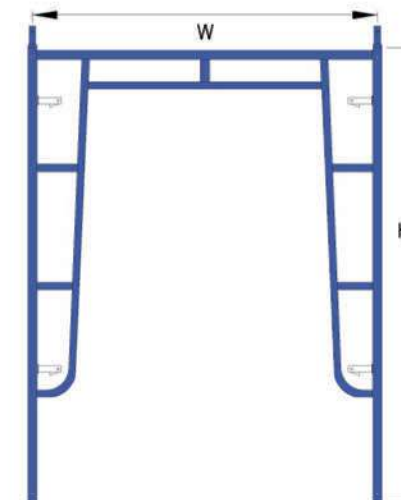

ITEM NO.	W	H
RSF 06	4'(1.219m)	5'7"(1.700m)
RSF 07	4'(1.219m)	6'4"(1.930m)
RSF 08	5'(1.524m)	4'(1.219m)
RSF 09	5'(1.524m)	6'4"(1.930m)
RSF 10	5'(1.524m)	6'7"(2.007m)

American Ladder Frame FINISH: Powder Coated

ITEM NO.	W	H
RSF 11	2'(0.609m)	5'(1.524m)
RSF 12	2'(0.609m)	6'4"(1.930m)
RSF 13	3'(0.914m)	4'(1.219m)
RSF 14	3'(0.914m)	5'(1.524m)
RSF 15	3'(0.914m)	6'(1.828m)

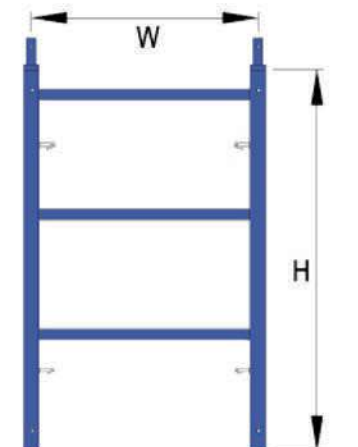

Aluminum Board With Hook

ITEM NO.	W	H
RSFA 01	19"(0.482m)	7'(2.133m)
RSFA 02	19"(0.482m)	8'(2.438m)
RSFA 03	19"(0.482m)	9'(2.743m)
RSFA 04	19"(0.482m)	10'(3.048m)

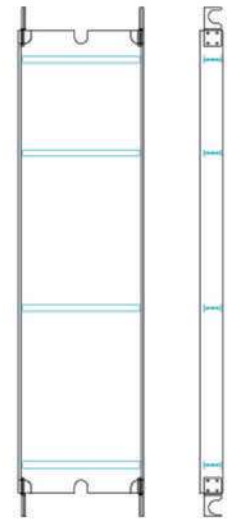
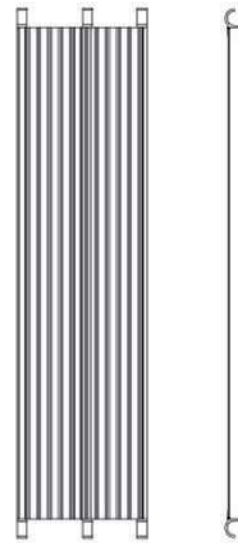

Aluminum Board With Plywood

ITEM NO.	W	H
RSFWP 01	19"(0.482m)	8'(2.438m)
RSFWP 02	19"(0.482m)	9'(2.743m)
RSFWP 03	19"(0.482m)	10'(3.048m)

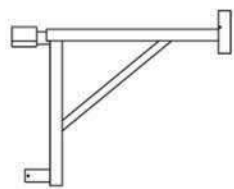

Side Bracket



Guard Rail Post

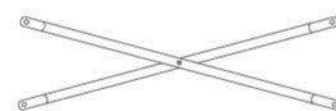

Cross Brace

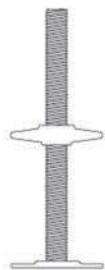

Base Screw Jack

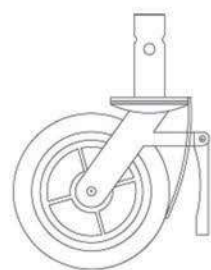

Caster

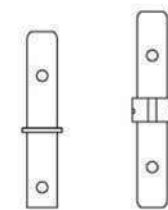

Coupling Pin

Other Accessories



Rivet Pin



Gravity Pin



Span Pin



Spring Pin



Pig Tail Pin

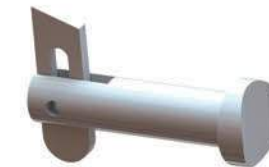

Flip Lock



Drop Lock

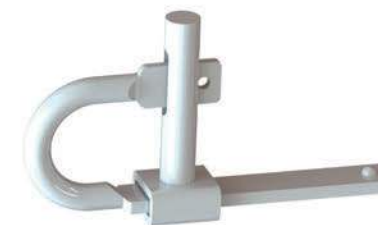

Fast Lock

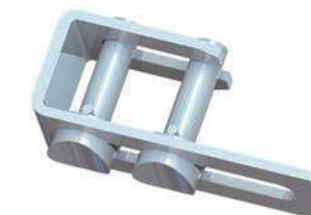

C-Lock

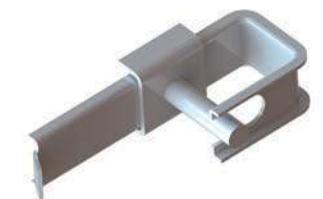

V-Lock

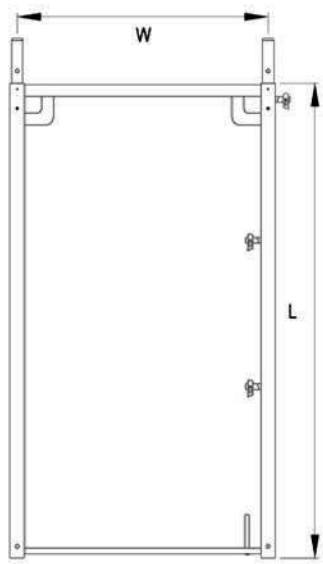

Euro Assembly Frame
FINISH: Hot-dip Galvanized

ITEM NO.	W	H
RSEF 01	2'5"(0.73m)	3'3"(1.00m)
RSEF 02	2'5"(0.73m)	6'7"(2.00m)

Aluminium Robust Hatch-type
FINISH: Plywood & Aluminum

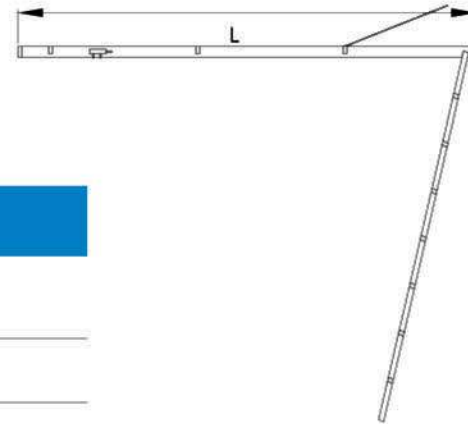

ITEM NO.	W	L
RSRH 01	0.61m	2.57m
RSRH 02	0.61m	3.07m

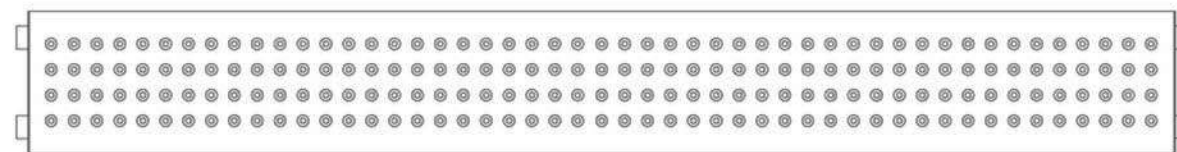

Steel Plank

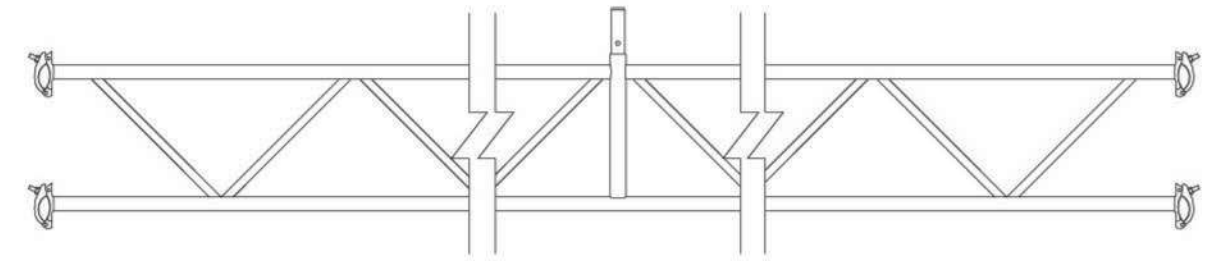

Transom

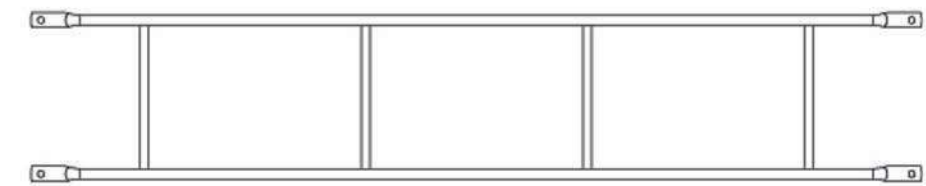

Double Front Guard Rail

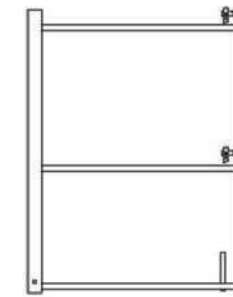

Euro End Guard Rail Support

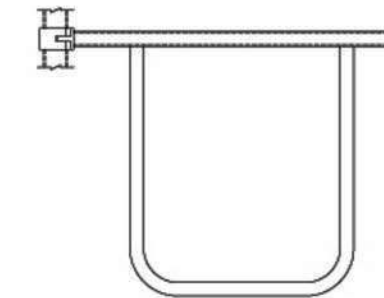

Double Guard Rail



Base Screw Jack

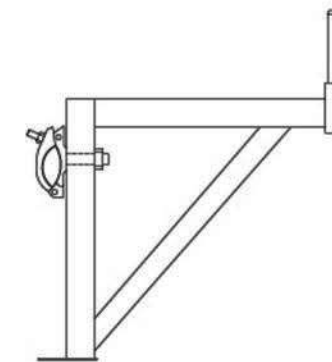

Bracket

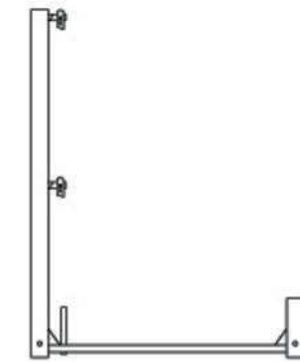

Guard Rail Support

Cuplock Scaffolding

Cuplock Standard

FINISH: Hot-dip Galvanized / Powder Coated



ITEM NO.	MATERIAL	L	WEIGHT APPROX.
RSCS 050	Q355 48.3 × 3.2mm	0.50m	3.56kg
RSCS 100	Q355 48.3 × 3.2mm	1.00m	6.22kg
RSCS 150	Q355 48.3 × 3.2mm	1.50m	8.87kg
RSCS 200	Q355 48.3 × 3.2mm	2.00m	11.52kg
RSCS 250	Q355 48.3 × 3.2mm	2.50m	14.17kg
RSCS 300	Q355 48.3 × 3.2mm	3.00m	16.83kg

Cuplock Diagonal Brace

FINISH: Hot-dip Galvanized Powder Coated



ITEM NO.	MATERIAL	L	WEIGHT APPROX.
RSCB 2342	Q235 48.3 × 2.5mm	1.219(4') × 2.0m	8.17kg
RSCB 2514	Q235 48.3 × 2.5mm	1.524(5') × 2.0m	8.84kg
RSCB 2693	Q235 48.3 × 2.5mm	1.803(5'11") × 2.0m	9.39kg
RSCB 2924	Q235 48.3 × 2.5mm	2.133(7') × 2.0m	10.09kg
RSCB 3153	Q235 48.3 × 2.5mm	2.438(8') × 2.0m	10.79kg
RSCB 3193	Q235 48.3 × 2.5mm	2.489(5'2") × 2.0m	10.91kg
RSCB 3394	Q235 48.3 × 2.5mm	2.743(9') × 2.0m	11.53kg
RSCB 3645	Q235 48.3 × 2.5mm	3.048(10') × 2.0m	12.30kg

Cuplock Ledger

FINISH: Hot-dip Galvanized / Powder Coated



ITEM NO.	MATERIAL	L	WEIGHT APPROX.
RSCL 27	Q355 48.3 × 3.2mm	2'7"(0.787m)	3.28kg
RSCL 30	Q355 48.3 × 3.2mm	3'(0.914m)	3.77kg
RSCL 36	Q355 48.3 × 3.2mm	3'6"(1.066m)	4.35kg
RSCL 40	Q355 48.3 × 3.2mm	4'(1.219m)	4.93kg
RSCL 50	Q355 48.3 × 3.2mm	5'(1.524m)	6.09kg
RSCL 60	Q355 48.3 × 3.2mm	6'(1.828m)	7.26kg
RSCL 70	Q355 48.3 × 3.2mm	7'(2.133m)	8.40kg
RSCL 80	Q355 48.3 × 3.2mm	8'(2.438m)	9.54kg
RSCL 90	Q355 48.3 × 3.2mm	9'(2.743m)	10.73kg
RSCL 100	Q355 48.3 × 3.2mm	10'(3.048m)	11.89kg

Cuplock Board Bracket

FINISH: Hot-dip Galvanized / Powder Coated

ITEM NO.	DESCRIPTION	L
RSCBB 1	One board	0.29m
RSCBB 2	Two board	0.57m
RSCBB 3	Three board	0.80m



Cuplock Steel Plank

FINISH: Hot-dip Galvanized

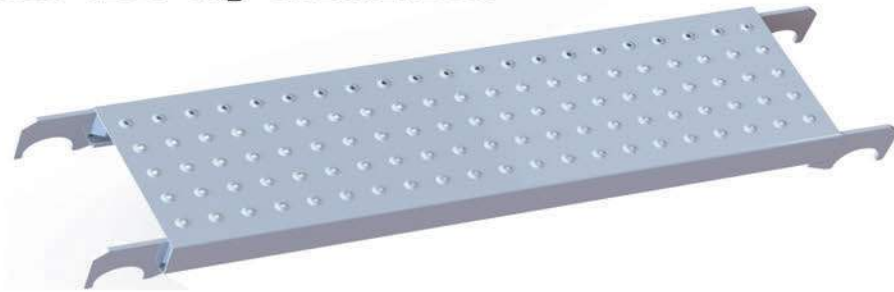

ITEM NO.	W	L	WEIGHT APPROX.
RSSP 040	0.2286m	1.219m	8.26kg
RSSP 050	0.2286m	1.524m	10.72kg
RSSP 511	0.2286m	1.803m	12.46kg
RSSP 070	0.2286m	2.133m	14.51kg
RSSP 080	0.2286m	2.438m	16.41kg
RSSP 082	0.2286m	2.489m	16.73kg
RSSP 090	0.2286m	2.743m	18.31kg
RSSP 100	0.2286m	3.048m	20.21kg

Cuplock Steel Ladder

FINISH: Hot-dip Galvanized

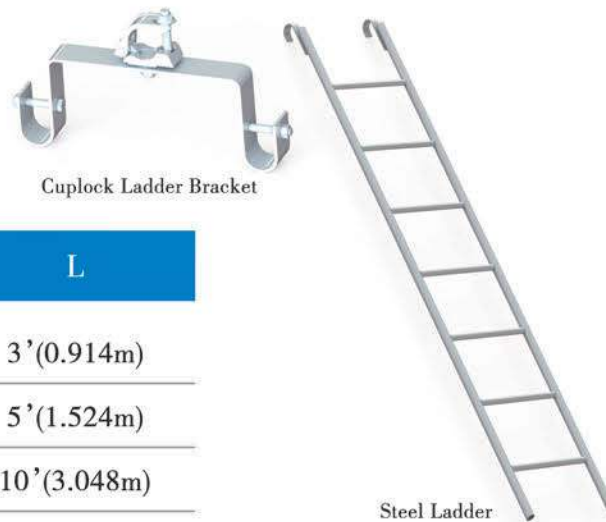

Cuplock Ladder Bracket

Steel Ladder

ITEM NO.	W	L
RSSL 030	0.369m	3'(0.914m)
RSSL 050	0.369m	5'(1.524m)
RSSL 100	0.369m	10'(3.048m)



Truss Ledger



Transom Beam



Cuplock U-head Screw Jack



Cuplock Base Jack



Cuplock Swivel Base Screw Jack

Time Saving: Cuplock scaffolding is a wise choice for temporary structures –performance staged, event grandstands, etc.Small teams can erect it safely and quickly.

Economical: Easily assembled system scaffolding saves time and labor costs.

Durable: All components are hot dip galvanized and manufactured according to international standard.

Early Stored:Individual pipe elements can be packed in bundles for easy storage and transportation.

For returns, material canbe packed in steel racks.

Kwikstage Standard
FINISH: Powder Coated



ITEM NO.	MATERIAL	L	WEIGHT APPROX.
RSKS 05	Q235 48.3 × 4mm	0.50m	4.71kg
RSKS 10	Q235 48.3 × 4mm	1.00m	7.03kg
RSKS 15	Q235 48.3 × 4mm	1.50m	10.06kg
RSKS 20	Q235 48.3 × 4mm	2.00m	13.10kg
RSKS 25	Q235 48.3 × 4mm	2.50m	16.14kg
RSKS 30	Q235 48.3 × 4mm	3.00m	19.18kg

Kwikstage Transom
FINISH: Powder Coated



ITEM NO.	MATERIAL	L	WEIGHT APPROX.
RSKT 050	50 × 50 × 5mm	0.50m	4.04kg
RSKT 073	50 × 50 × 5mm	0.73m	5.88kg
RSKT 100	50 × 50 × 5mm	1.00m	8.04kg
RSKT 127	50 × 50 × 5mm	1.27m	10.20kg
RSKT 150	50 × 50 × 5mm	1.50m	12.04kg
RSKT 183	50 × 50 × 5mm	1.83m	14.67kg
RSKT 244	50 × 50 × 5mm	2.44m	19.55kg
RSKT 300	50 × 50 × 5mm	3.00m	24.02kg

Kwikstage Scaffolding

Kwikstage Diagonal Brace
FINISH: Powder Coated

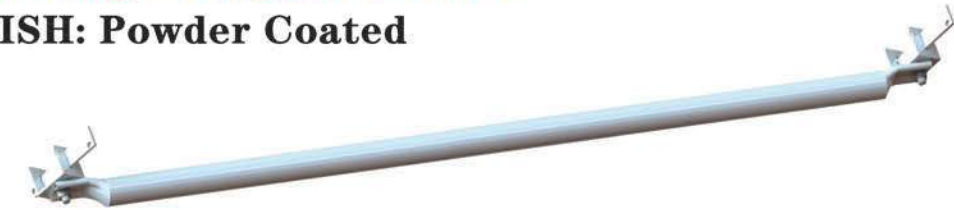

ITEM NO.	MATERIAL	L	WEIGHT APPROX.
RSKB 170	Q235 48.3 × 3mm	1.70m	7.54kg
RSKB 200	Q235 48.3 × 3mm	2.00m	8.62kg
RSKB 270	Q235 48.3 × 3mm	2.70m	10.7kg
RSKB 320	Q235 48.3 × 3mm	3.20m	13.15kg
RSKB 360	Q235 48.3 × 3mm	3.60m	14.41kg

Kwikstage Ledger
FINISH: Powder Coated



ITEM NO.	MATERIAL	L	WEIGHT APPROX.
RSKL 073	Q235 48.3 × 3mm	0.73m	3.32kg
RSKL 010	Q235 48.3 × 3mm	1.00m	4.35kg
RSKL 127	Q235 48.3 × 3mm	1.27m	5.37kg
RSKL 150	Q235 48.3 × 3mm	1.50m	6.25kg
RSKL 183	Q235 48.3 × 3mm	1.83m	7.51kg
RSKL 244	Q235 48.3 × 3mm	2.44m	9.83kg
RSKL 300	Q235 48.3 × 3mm	3.00m	11.53kg

Kwikstage Tie Bar

FINISH: Powder Coated

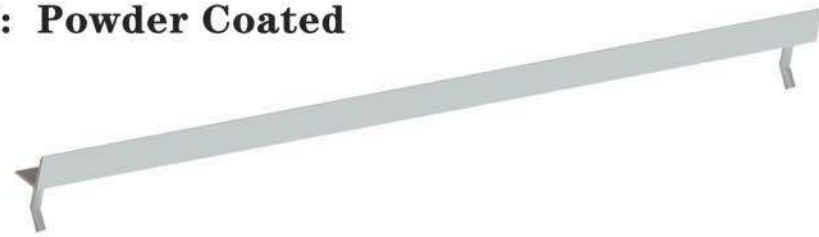

ITEM NO.	MATERIAL	L	WEIGHT APPROX.
RSTB 073	40 × 40 × 4mm	0.73m	2.15kg
RSTB 100	40 × 40 × 4mm	1.00m	3.03kg
RSTB 127	40 × 40 × 4mm	1.27m	3.90kg
RSTB 150	40 × 40 × 4mm	1.50m	4.65kg
RSTB 183	40 × 40 × 4mm	1.83m	5.72kg
RSTB 244	40 × 40 × 4mm	2.44m	7.70kg

Kwikstage Plank

FINISH: Hot-dip Galvanized

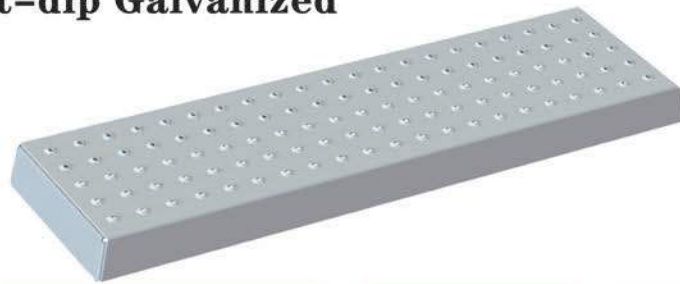

ITEM NO.	W	L	WEIGHT APPROX.
RSKP 073	0.2286m	0.73m	5.52kg
RSKP 100	0.2286m	1.00m	7.19kg
RSKP 127	0.2286m	1.27m	9.13kg
RSKP 150	0.2286m	1.50m	10.83kg
RSKP 183	0.2286m	1.83m	12.33kg
RSKP 244	0.2286m	2.44m	16.11kg
RSKP 300	0.2286m	3.00m	19.85kg

Other Accessories



Hop Up



Hop Up

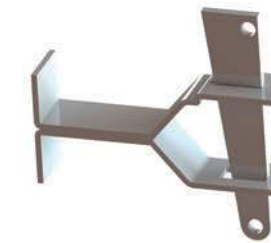

Toe Board Bracket



End Toe Board Clip



Steel Stair



Kwikstage base jack

Haky Scaffolding

Haky Standard

FINISH:Hot-dip Galvanized



ITEM NO.	L	WEIGHT APPROX.
RSHKS 15	1.50m	7.96kg
RSHKS 20	2.00m	10.61kg
RSHKS 30	3.00m	15.92kg

Haky Ledger

FINISH:Hot-dip Galvanized



ITEM NO.	L	WEIGHT APPROX.
RSHKL 30	3.00m	14.80kg

Haky Single Tube Beam

FINISH:Hot-dip Galvanized



ITEM NO.	L	WEIGHT APPROX.
RSHSTB 16	1.605m	5.40kg

Haky Guardrail Frame

FINISH:Hot-dip Galvanized

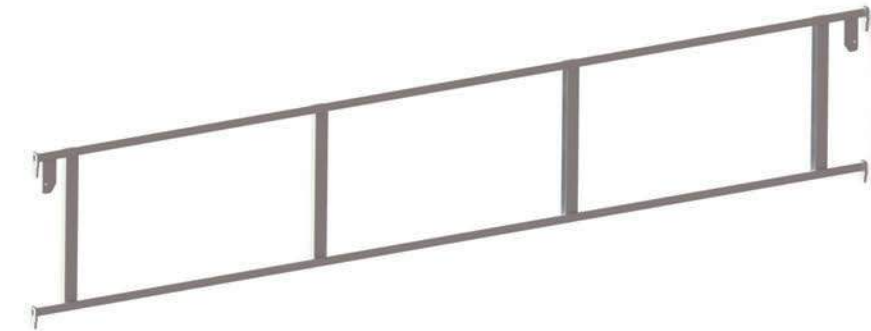

ITEM NO.	L	DESCRIPTION
RSHGF 21	1.605m	Haky Guardrail Frame
RSHGF 30	3.000m	Haky Guardrail Frame



Stair

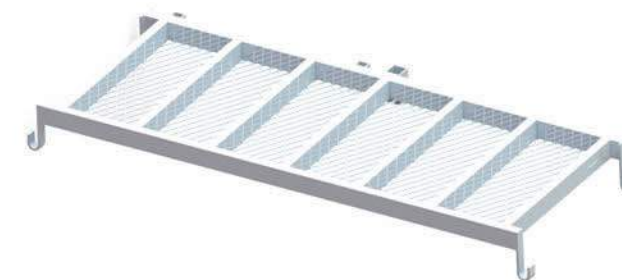

Landing

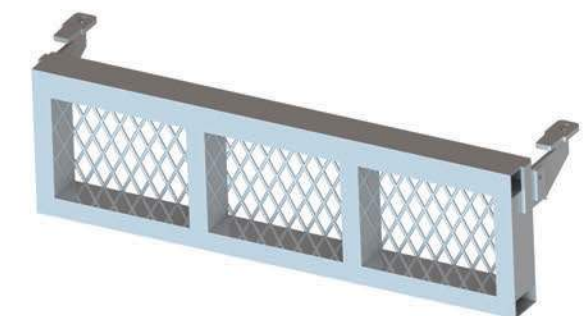

Entrance Step

Tube with End Fitting
FINISH:Hot-dip Galvanized



ITEM NO.	L	DESCRIPTION
RSST 01	4'	Tube with End Fitting
RSST 02	6'	Tube with End Fitting
RSST 03	8'	Tube with End Fitting
RSST 04	10'	Tube with End Fitting
RSST 05	13'	Tube with End Fitting

All kinds of thickness & surface requirements. Right angle coupler

- Right angle coupler :** A coupler used for connecting two tubes crossing at a right angle. Class A and class B right angle couplers have the same requirements, except that class B couplers have a higher load capacity and a minimum requirement for torsional rigidity.
- Swivel coupler :** A coupler used for connecting two tubes crossing at any angle.
- Parallel coupler :** A coupler used for connecting two parallel tubes.
- Sleeve coupler :** A coupler used for jointing two tubes located co-axially and whose purpose is to transmit tensile and compressive and bending forces. Class A and class B sleeve couplers have the same requirements except that class B couplers have a minimum requirement for strength in bending and a higher tensile strength requirement. There are two basic types of sleeve couplers: Sleeve coupler functioning by friction, and Sleeve couplers working with shear pins.
- Putlog coupler :** coupler used for fixing a putlog or transom to a ledger.
- Loose spigot :** An internal component used for aligning tubes co-axially and able to transmit compressive forces.
- Base-plate :** A rigid plate used for spreading a load over a greater area. If it has a means of vertical adjustment, it is called an "adjustable base-plate".



Color Options For Powder Coated

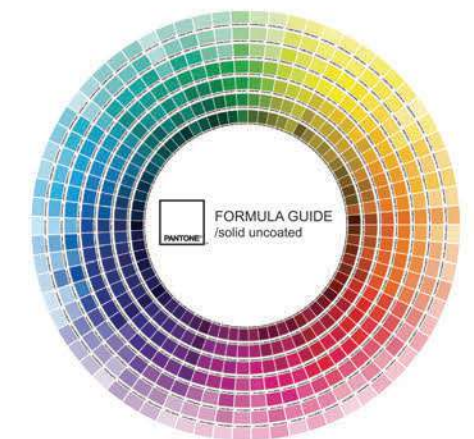

Hundreds of color is available for choosing in Pantone. Checking the Pantone item number. There is always a color satisfying you.

Shoring system



Shoring Frame FINISH: Powder Coated

ITEM NO.	W	H
RSSF 01	2'(0.610m)	3'(0.914m)
RSSF 02	4'(1.219m)	2'(0.610m)
RSSF 03	4'(1.219m)	3'(0.914m)
RSSF 04	4'(1.219m)	4'(1.219m)
RSSF 05	4'(1.219m)	5'(1.524m)
RSSF 06	4'(1.219m)	6'(1.828m)

Double Holes or Single Hole Angle Cross Brace FINISH: Powder Coated

ITEM NO.	W	H
RSACB 01	3' & 4'	4'(1.219m)
RSACB 02	3' & 4'	5'(1.524m)
RSACB 03	3' & 4'	6'(1.828m)
RSACB 04	3' & 4'	7'(2.134m)
RSACB 05	3' & 4'	8'(2.438m)
RSACB 06	3' & 4'	10'(3.048m)



Heavy Duty Props FINISH: Hot-dip Galvanized



Heavy Duty Tripod

ITEM NO.	MIN	MAX	External Tube	Internal Tube
RSHP 01	1.10m	1.80m	60.3 × 3.0mm	48.3 × 3.2mm
RSHP 02	1.50m	2.50m	60.3 × 3.0mm	48.3 × 3.2mm
RSHP 03	1.80m	3.20m	60.3 × 3.0mm	48.3 × 3.2mm
RSHP 04	2.20m	4.00m	60.3 × 3.0mm	48.3 × 3.2mm
RSHP 05	2.80m	5.00m	60.3 × 3.0mm	48.3 × 3.2mm

Light Duty Props FINISH: Powder Coated



Light Duty Tripod

ITEM NO.	MIN	MAX	External Tube	Internal Tube
RSLP 01	1.60m	2.80m	57.0 × 2.0mm	48.3 × 2.5mm
RSLP 02	1.80m	3.20m	57.0 × 2.0mm	48.3 × 2.5mm
RSLP 03	2.0m	3.50m	57.0 × 2.0mm	48.3 × 2.5mm

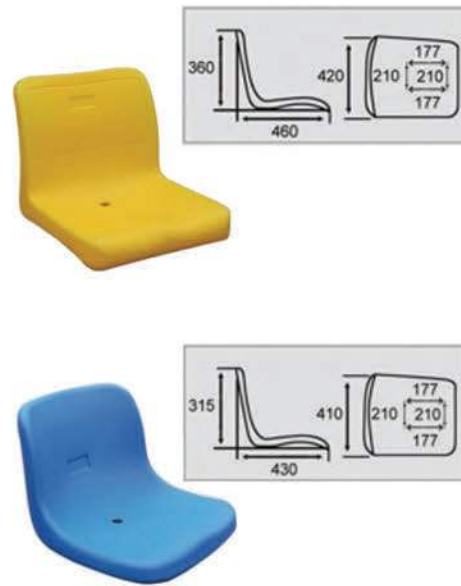

Seat type : plastic chairs Seat fixed way : bolt & nut
 Supported steel : Q235 with galvanized
 Board covers : 18mm / 21mm plywood
 Safety Railing : Height 1100mm, steel tube with galvanized

Seat type : steel board Seat fixed way : bolt & nut
 Supported steel : Q235 with galvanized
 Safety Railing : Height 1100mm, steel tube with galvanized

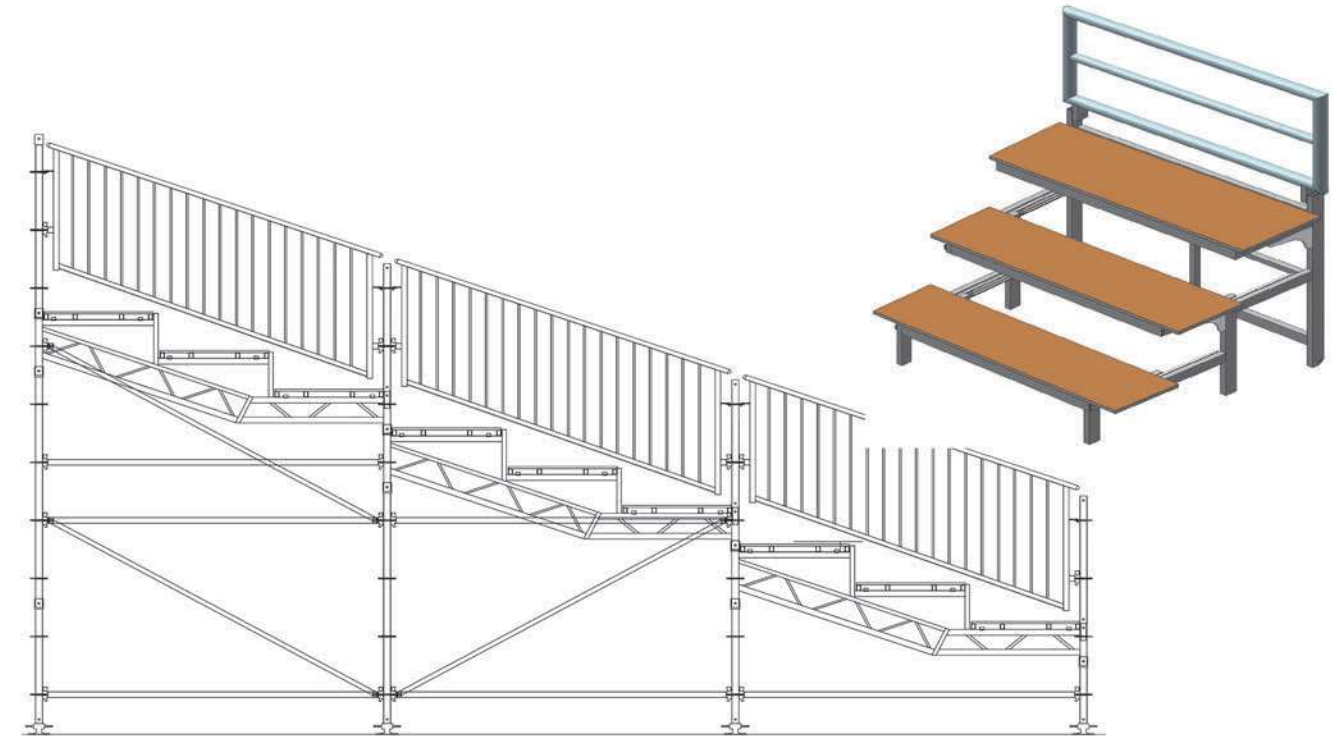
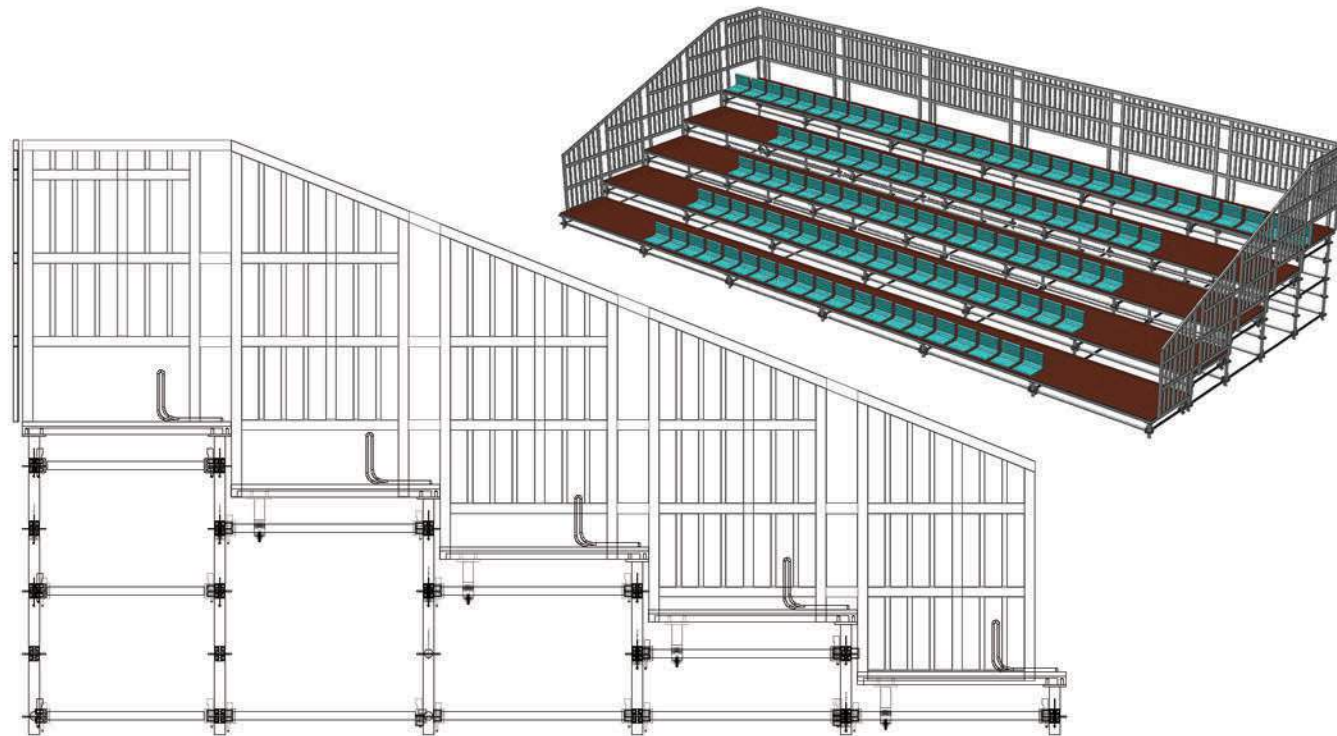

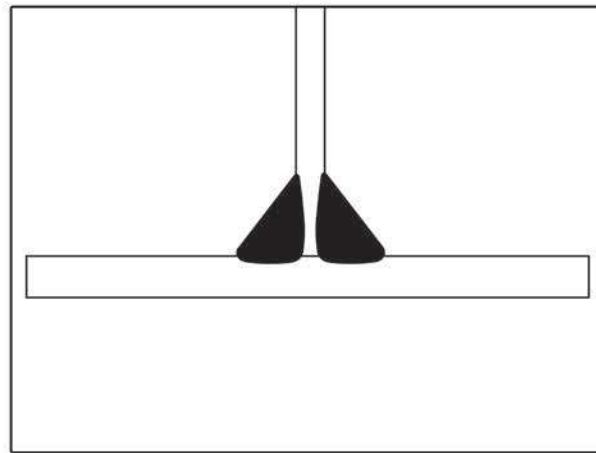
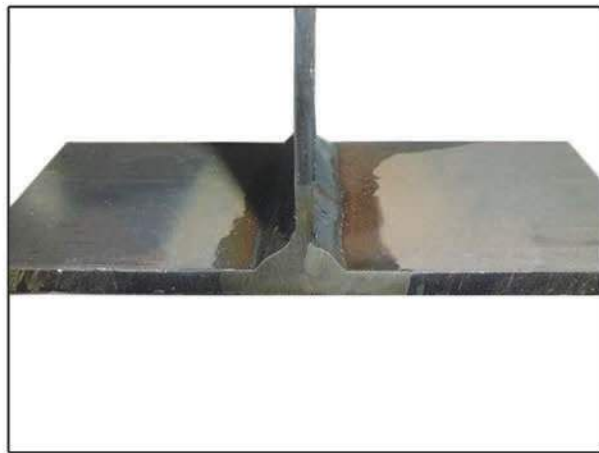
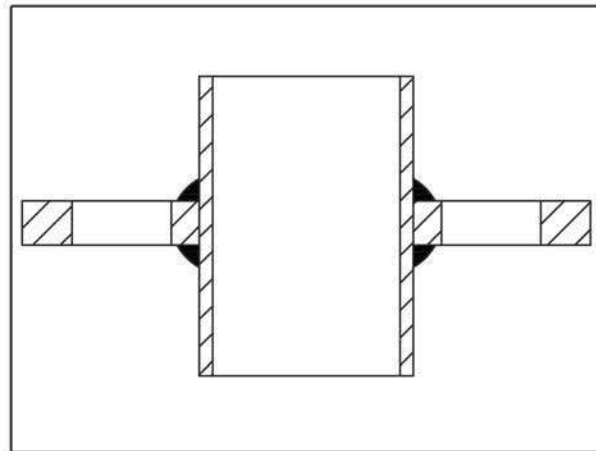
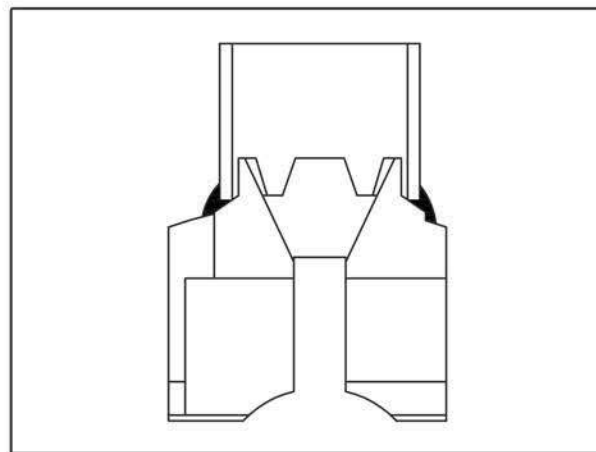

Plate with plate welding



Rosette with tube welding



Casting end with tube welding

As we know, welding is a key factor to the quality of scaffolding, which is equal to or even more important than the quality of raw material. We pay much attention on the welding quality – our engineers issue wPs(Welding Procedure Specification) & PQR(Procedure Qualification Report) for each welding product. And every welder needs to weld and cut one welding sample to check the welding penetration everyday before they start to do their welding work.

The tests are conducted based on ANSI A 10.8, AS/NZS 1576, EN12811 standard, or the related standard required by customer.



Base Jack (Test in different nut height)



Steel Plank (Uniformly distributed load test)



Ringlock Ledger (Load capacity test)



Kwikstage Ledger (Bending moment)



Ringlock Standard (Load capacity of single standard)



Ringlock Tower (One unit test)



ISO 9001:2008



ISO 14001



OHSAS 18001

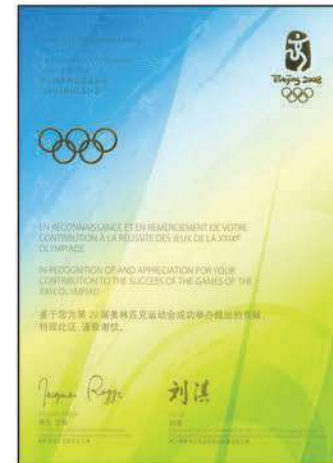

Olympic Certificate

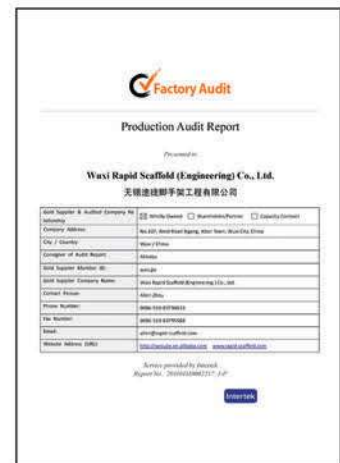

Factory Audit



CE Certificate (EN 1004:2004)



CE (Euro Frame Scaffolding)



CE (Ringlock Scaffolding)



ANSI A10.8 (Ringlock Scaffolding)



AS/NZS 1576.3 (Ringlock Scaffolding)



SGS Certificate



AS/NZS 1576.3 (Kwikstage Scaffolding)

